

BAYOU CLASSIC[®]

SAFETY ALERTS ASSEMBLY INSTRUCTIONS CARE AND USE MANUAL

Please locate the model number on the box in which your cooker was packed and write it here for future reference.

**READ OPERATING INSTRUCTIONS BEFORE USING THIS COOKER.
SAVE THIS MANUAL FOR FUTURE REFERENCE.**

For Questions and Information call us at:

1-800-864-6194

Monday - Friday (8:00am - 5:00pm CST)

Barbour International, Inc.

P.O. Box 1839

Brandon, MS 39043

www.thebayou.com



**Failure to follow these instructions could result in fire or explosion
which could cause property damage, personal injury or death!**



Read and understand this manual before using this product.

1. Sober adult operation **ONLY!** Read and understand this manual before using the product. The use of alcohol, prescription or nonprescription drugs may impair your ability to properly assemble or safely operate this appliance.
2. This cooker, like any gas appliance, can be extremely dangerous! It can burn you, scald you with hot oil or water, or start a fire. Misuse of an outdoor cooker can result in serious personal injury or property damage. The warnings and safety instructions in this manual must be followed to provide reasonable safety and efficiency in using this unit.
3. LP (propane) gas is colorless, tasteless, heavier than air, and is both flammable and explosive. Combustion of propane consumes oxygen and produces carbon monoxide (a poisonous gas). Therefore, never operate an outdoor cooker inside a building or confined area where ventilation may be restricted. Make sure the LP Cylinder and the appliance is placed in an open area. Do not obstruct the flow of combustion and ventilation air.
4. **Never leave cooker unattended.** Most accidents occur as a result of leaving the cooker unattended.
When Frying... a cooker left unattended may eventually over heat, resulting in a serious grease fire.
When Boiling... a cooker left unattended may eventually boil over. Water can splash down on the burner and put out the fire resulting in propane gas being released out into the cooking area.
When Steaming... a cooker left unattended may eventually evaporate all the water inside the steam pot. If water is allowed to evaporate completely, the heat from this cooker will melt a hole into the bottom of the pot, resulting in a loss of the pot and the food inside.
5. This is an **ATTENDED** appliance. Do **NOT** leave this appliance unattended while heating oil, grease or water, cooking food or when hot after use [oil, grease or water above 100°F (38°C)]. Heated liquid can remain at scalding temperatures long after cooking has ended.
6. Use **ONLY** on a level, stable non-combustibles surface like brick, concrete or dirt. Do **NOT** use this appliance on any surface that will burn or melt like wood, asphalt, vinyl, or plastic.
7. This appliance is for **OUTDOOR** use only. Do **NOT** use in a building, garage or any other enclosed area. Do **NOT** use on wooden decks, under roof overhangs, on porches, carports or at garage door openings. This appliance is **NOT** intended to be installed in or on recreational vehicles and/or boats. This appliance is not intended for and should **NEVER** be used as a heater.
8. Do **NOT** locate this appliance under **ANY** overhead construction. Keep a minimum clearance of 10 feet from the sides, front and back of the appliance to **ANY** construction. Keep the area clear and free of any combustible material such as household chemicals, paint, gasoline and other flammable vapors and liquids.



9. Keep the fuel supply hose away from any heated surfaces.
10. Clean and inspect the hose before each use of the appliance. If there is evidence of abrasion, wear, cuts or leaks, the hose must be replaced prior to the appliance being put into operation. Replacement hose assemblies for Bayou Classic Cookers are: Single Burner Cookers - Model #5HPR, Double & Triple Burner Cookers - Model #3HPH, and Jet Cookers - Model #5HPR-1.
11. Keep children and pets away from the appliance at all times.
12. Do NOT move the appliance when in use. Allow the cooker to cool before moving or storing.

DO NOT LEAVE UNATTENDED WHILE COOKER IS IN USE OR IS STILL HOT! (Above 100°F)

13. When cooking with oil or grease, the thermometer provided **MUST** be used. Follow instructions in this manual for proper installation and use of thermometer. Follow instructions to make sure thermometer is working properly.
14. NEVER let the oil or grease temperature get hotter than 350°F (177°C). If the temperature goes above 350°F (177°C) or if oil begins to smoke, IMMEDIATELY turn burner OFF. After reaching 450°F, oil or grease temperature can rapidly increase to its point of spontaneous combustion... a serious grease fire. Therefore, never leave cooker unattended, always monitor the thermometer.
15. When cooking with oil or grease, fire extinguishing materials shall be readily accessible. In the event of an oil or grease fire do NOT attempt to extinguish with water. Turn off the gas at the supply cylinder. Use a Type BC dry chemical fire extinguisher or smother fire with dirt, sand or baking soda.
16. NEVER overfill the cooking pot with oil, grease or water. Follow instructions in this manual for establishing proper oil, grease or water levels.
17. Failure to completely thaw and dry food may cause oil or grease to overflow. When frying with oil or grease, all foods products **MUST** be completely thawed and towel dried to remove excess water. Follow instructions in this manual for frying foods.
18. In the event of rain while cooking with oil or grease, IMMEDIATELY turn off burner(s) and gas supply, then cover cooking vessel. Do NOT attempt to move the appliance or the cooking vessel.
19. Do NOT place an empty cooking vessel on the appliance while in operation. The intense heat will melt an empty pot. Use caution when placing anything on the cooking vessel.



WARNING

20. In sunlight or other bright light, the flame may be almost invisible. Use extreme caution keeping hands, hair and clothing away from the cooker. Never put face or hands over burner while lighting. Make sure to turn cooker off when not in use. Always wear cooking mitts when handling the cooker, cookware, cooking utensils and accessories.
21. Use only D.O.T. certified (US Department of Transportation) LP gas cylinders. Always close LP cylinder valve after use. Always use and store LP cylinder in an upright position. Never store or transport LP cylinders in occupied enclosures. Do not store a spare LP Cylinder under or near this appliance. Carefully read and follow instructions on LP cylinder.
22. Never fill the Cylinder beyond 80% full. All LP Cylinders in excess of 2.2 lbs(1.0 Kg.) propane capacity, must include a collar to protect the cylinder valve.
23. The valve on the propane tank is the "ON/OFF" valve. When finished cooking, or in case of an emergency, turn the tank valve clockwise to the "OFF" position. Be sure to close the tank valve before disconnecting the hose. Caution - The valve on the hose and regulator assembly controls the flame intensity only. It is not an "ON/OFF" valve.
24. Always check for gas leaks before lighting. (See section for Leak Test Instructions.)
25. Follow lighting procedures as stated in this manual. Use a fireplace match or gas appliance butane lighter.
26. Always wear shoes while cooking. Always wear mitts when handling the cooker, pots, and accessories.
27. Use Bayou Classic appliances only in accordance with state and local ordinances and codes. In the absence of local codes, installation must conform with the National Fuel Gas Code, ANSI Z223.1/NFPA 54, Storage and Handling of Liquefied Petroleum Gases, ANSI/NFPA 58 or CSA B149.1, Natural Gas and Propane Installation Code; or CGA-B149.2 Installation Code.
28. Bayou Classic gas appliances are not intended for use in a Commercial Setting.
29. Bayou Classic appliances are designed for use with propane gas using **ONLY** the hose and regulator assembly supplied with the product. For replacement parts call: 1800-864-6194. Accessories not recommended by Bayou Classic must not be used with Bayou Classic Appliances. Never use with natural gas.
30. Carefully read and follow instructions for assembly, checking for gas leaks, lighting, checking accuracy of a thermometer and cooking.

Failure to comply with these warnings and instructions can result in property damage, personal injury and death.

Proper Placement Instructions

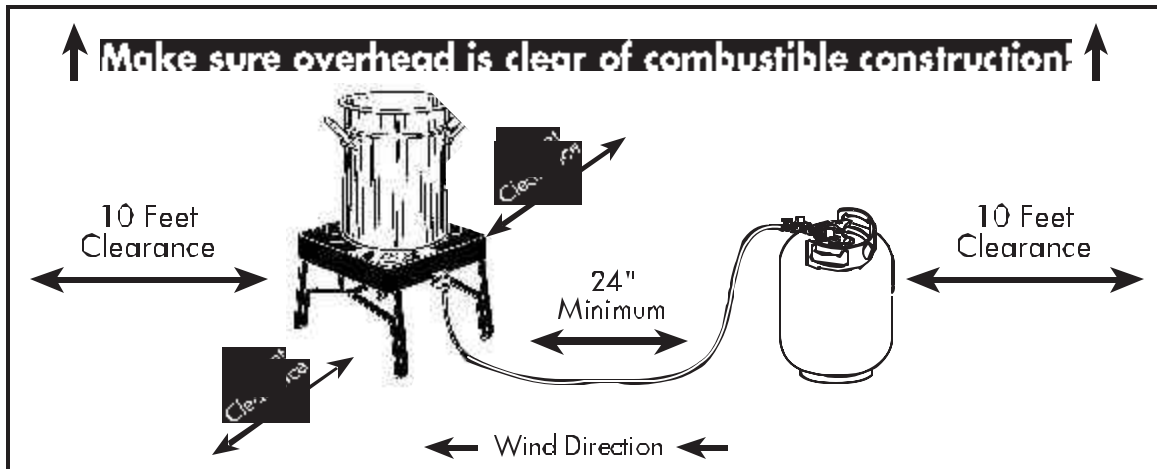

Important Precautions

1. Appliance must be in open area with at least 10 feet of clearance in all directions to nearest structure or combustible construction.
2. There must be no combustibles or roof overhead. The appliance shall NOT be located under overhead unprotected combustible construction.
3. There must be at least 2 feet (24") of space between LP gas tank and cooker.
4. Locate the LP gas tank "upwind" from the cooker. The LP gas tank and cooker must be located so that any wind is blowing the heat of the cooker away from the gas tank. This also helps fire prevention by blowing the flames of a grease fire away from the gas tank.
5. Center the pot over the burner on the cooker. Use caution when choosing the size of the pot to use on your cooker to avoid hazards. For example, a large pot on a tall cooker runs the risk of tipping. Use large pots only on short cookers.

LP Gas Cylinder Information

Bayou Classic Outdoor Cookers are manufactured for use with 20 lb LP Gas cylinders. Important precautions to remember about LP Gas cylinders include:

1. Always read, understand and follow the cylinder manufacturer's instructions.
2. The LP-gas supply cylinder to be used must be constructed and marked in accordance with the specifications for LP-gas cylinders of the U.S. Department of Transportation (DOT) or the National Standards of Canada, CAN/CSA-B339, Cylinders, Spheres and Tubes for the Transportation of Dangerous Goods.
3. Make sure that the cylinder valve has the proper receptacle for a handwheel hose connection.
4. When appliance is not in use, the gas must be turned off at the supply cylinder.
5. Storage of an appliance indoors is permissible only if the cylinder is disconnected and removed from the appliance.
6. Cylinder must be stored outdoors. Out of the reach of children and must NOT be stored in a building, garage or any other enclosed area.



WARNING

FAILURE TO FOLLOW THESE INSTRUCTIONS EXACTLY, MAY CAUSE A FIRE RESULTING IN SERIOUS INJURY OR DEATH.

Hose Attachment Instructions on All Models

The hose and regulator is a pre assembled unit. Do not take apart. Simply connect the hose and regulator assembly to the LP gas cylinder and to the cooker.

If there is evidence of abrasion, wear, cuts or leaks, the hose must be replaced prior to the appliance being put into operation. Call 1 800 864 6194 for hose replacement. MF 8:00 5:00 CST.

1. Make sure the valve on the LP cylinder is clean. Connect the hose to the cylinder valve by turning the handwheel to the right. Hand tighten. (figure #1) **~ Handwheel Connector conforms to new standards regulating propane tanks ~**

PRESET REGULATOR WITH SIDE VALVE

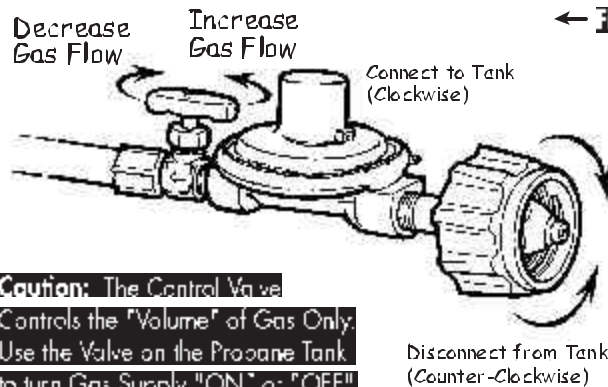

ADJUSTABLE REGULATOR

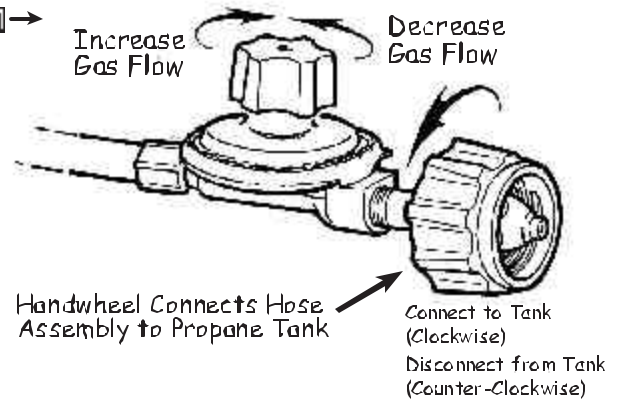

2. Attach hose with fitting to the burner as shown.

All Single Burner Cookers
(except Jet Cookers)

Turn Air Control Shutter to
adjust flame quality

Turn Clockwise
Wrench Tighten
(but not too tight)

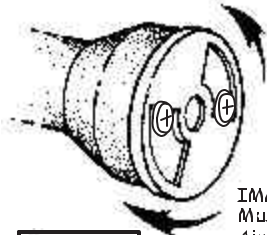

IMPORTANT:
Must be able to turn
Air Control Shutter...
do NOT over tighten!



Final Assembly

Figure #2

Turn Air Control Shutter to
adjust flame quality

Turn Clockwise
Wrench Tighten
(but not too tight)



IMPORTANT:
Must be able to turn
Air Control Shutter...
do NOT over tighten!

Check For Gas Leaks

After assembly is complete, always check for gas leaks before lighting.

1. Close the regulator control valve on the hose. This shuts off the flow of gas from the regulator to the burner.
2. Open LP cylinder valve by 1/8 to 1/4 turn. This allows gas into the regulator and stops it at the closed regulator valve.
3. Using a small brush or spray bottle, splash on a soapy liquid (ex. Dishwashing liquid and water, or 50% non ammonia soap and 50% water) on the connections around the regulator and cylinder connection. (Figure #3) Any bubbles that appear indicate a gas leak. If so, turn off the gas and tighten the fittings some more.

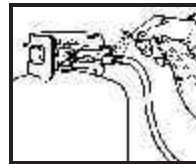

Figure #3

Spray ALL connections
with a soapy liquid to
check for gas leaks.
Appearance of bubbles
indicates a leak.

Do Not use cooker if gas leak can not be stopped. Call 1 800 864 6194 for assistance. MF 8:00 5:00 CST.

4. After you are certain there are no leaks, turn tank valve and regulator valve to "OFF" position. Wait 5 minutes for any gas fumes to go away before lighting the burner.

Lighting Instructions

1. When you are sure there are no leaks, turn cylinder valve and regulator control valve on hose to the closed position.
2. Reopen cylinder valve fully.
3. Have a standard match, fireplace match or long nosed propane lighter lit and ready to place over the burner.
4. Before lighting, Turn air control shutter on the burner to an almost closed position. After lighting, turn air control shutter to open position to achieve a better flame.
5. Light the burner from the bottom, keeping hands and face away from the top of the cooker. (See Illustrations Below)

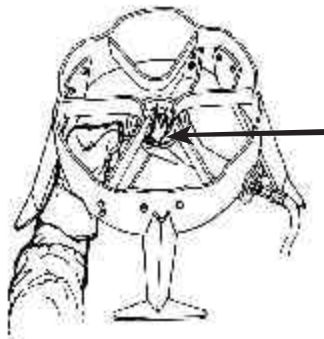

**Light
Burner
Here!**

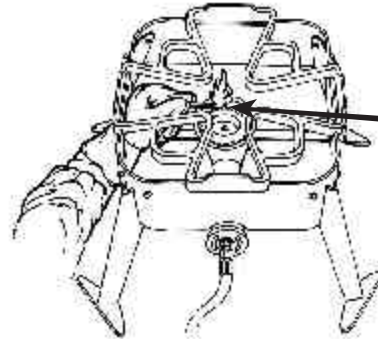

**Light
Burner
Here!**

6. Place lighter over the burner, then slowly open regulator valve until burner ignites.
7. Adjust air shutter on burner for a blue flame. (In direct sunlight, flame may appear clear.)
8. Adjust the regulator control valve for desired flame height. (See Figure #1 on previous page.)
9. When lighting for the first time, you will smell paint burning at the top for a few minutes... This is normal.
10. When finished using the cooker, turn off gas from the cylinder valve first. It will take a few seconds for the fire to go out and for the propane gas to "bleed" from the hose and regulator assembly. After the fire is completely out, turn regulator control valve to the "OFF" position.
11. To re light, repeat steps 1-8. Always use **CAUTION** as cooker will be hot.



CAUTION: Before lighting the burner, check that the venturi tube is free of obstruction and insects or insect nests. A clogged venturi may result in a fire beneath the appliance.

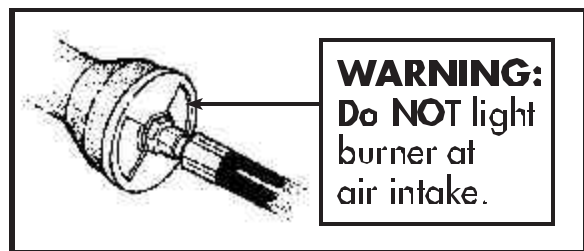

Trouble Shooting Tips

Problems with proper Gas Flow:

This Bayou Classic cooker and most propane tanks are equipped with a safety device to shut off the flow of gas should the hose be cut or severed. Sometimes this safety device may be tripped when lighting the cooker. To prevent this, ALWAYS make sure the regulator valve is in the closed position (figure #6) before opening the valve on the LP gas tank.

**Clockwise
to closed position**

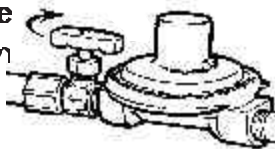

PRESET REGULATOR WITH SIDE VALVE

Figure #6



**Counter-Clockwise
to closed position**

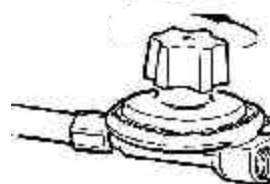

ADJUSTABLE REGULATOR

Safety Precautions & Warnings

WARNING

Failure to follow these instructions could result in fire or explosion which could cause property damage, personal injury or death!



ALWAYS
operate in a clear open
area away from buildings,
trees and shrubs.



OUTDOOR USE ONLY!
Do not operate inside
garages or carports.



NEVER
LEAVE COOKER
UNATTENDED!



NEVER
use under any
roof or overhang.



NEVER
use on decks, boats or
any combustible surface!



NEVER
place flammable or
combustible materials
within 25-ft of cooker.



NEVER
cover pot with lid when
preheating oil or frying.



NEVER!
let children or pets near
the cooking area
during and after use.



NEVER!
No barefeet or sandals
when cooking.



HOT!
Unit is extremely hot during and
after use. Allow 2 hours for unit
to cool down before touching.



ALWAYS
wear protective mitts, gloves,
goggles and long sleeve
clothing when cooking.



ALWAYS
use an accurate thermometer
to monitor temperature when
preheating oil or frying.

Remember: Think Safety and Use Common Sense!